

Description

The 5KP Series is designed specifically to protect sensitive electronic equipment from voltage transients induced by lightning and other transient voltage events.

Applications

- Communication Equipment
- Security & Protection
- Industrial Control Equipment
- Power Supply
- Automotive Electronics
- New Energy
- Lightning Protection

Functional Diagram

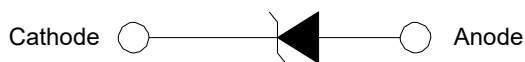

Uni-Directional



Bi-Directional

Features

- 5 kW peak pulse capability at 10/1000 μ s waveform, repetition rate (duty cycles):0.01%
- Glass passivated chip junction in P600 Package
- Fast response time: typically less than 1.0 PS from 0 Volts to BV min
- Excellent clamping capability
- Typical failure mode is short from over-specified voltage or current
- Whisker test is conducted based on JEDEC JESD201A per its table 4a and 4c
- IEC 61000-4-2 ESD 30 kV (Air), 30 kV (Contact)
- EFT protection of data lines in accordance with IEC 61000-4-4
- Low incremental surge resistance
- Typical $I_R \leq 2 \mu$ A for $V_{BR} \text{ min} > 12 \text{ V}$
- High temperature to reflow soldering guaranteed: 260 °C/40 sec / 0.375", (9.5mm) lead length, 5 lbs., (2.3 kg) tension
- $V_{BR} @ T_J = V_{BR}@25 \text{ }^\circ\text{C} \times (1 + \alpha T \times (T_J - 25))$
(αT : Temperature Coefficient, typical value is 0.1%)
- UL Recognized compound meeting flammability rating V-0
- Matte tin lead-free plated
- Halogen free and RoHS compliant
- Pb-free E3 indicates that 2nd level interconnect is Pb-free and the terminal finish material is tin(Sn) (IPC/JEDEC J-STD-609A.01)

Package Outline Dimensions (P600)

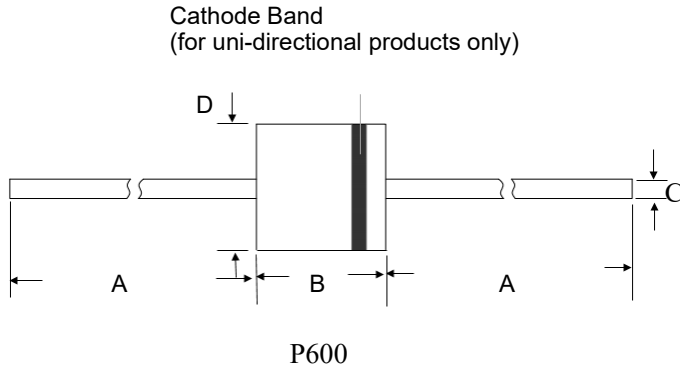

Symbol	Millimeters		Inches	
	Min.	Max.	Min.	Max.
A	25.40	-	1.000	-
B	8.60	9.10	0.340	0.360
C	1.22	1.36	0.048	0.054
D	8.60	9.10	0.340	0.360

Maximum Ratings and Characteristics

($T_A = 25\text{ }^\circ\text{C}$ unless otherwise specified.)

Parameter	Symbol	Value	Unit
Peak Pulse Power Dissipation by 10/1000 μs Test Waveform (Fig.2)(Note 1)	P_{PPM}	5	kW
Steady State Power Dissipation on Infinite Heat Sink at $T_L=75\text{ }^\circ\text{C}$	P_D	8.0	W
Peak Forward Surge Current, 8.3 ms Single Half Sine Wave Unidirectional Only (Note 2)	I_{FSM}	400	A
Maximum Instantaneous Forward Voltage at 100 A for Unidirectional Only (Note 3)	V_F	3.5/5.0	V
Operating Junction and Storage Temperature Range	T_J, T_{STG}	-55 to 175	$^\circ\text{C}$
Typical Thermal Resistance Junction to Lead	$R_{\theta JL}$	8.0	$^\circ\text{C/W}$
Typical Thermal Resistance Junction to Ambient	$R_{\theta JA}$	40	$^\circ\text{C/W}$

Notes:

1. Non-repetitive current pulse, per Fig. 4 and derated above $T_J(\text{initial})=25\text{ }^\circ\text{C}$ per Fig. 3.
2. Measured of 8.3 ms single half sine-wave or equivalent square wave, duty cycle=4 pulses per minute maximum.
3. $V_F < 3.5\text{ V}$ for single die parts and $V_F < 5.0\text{ V}$ for stacked-die parts.

Part Numbering System

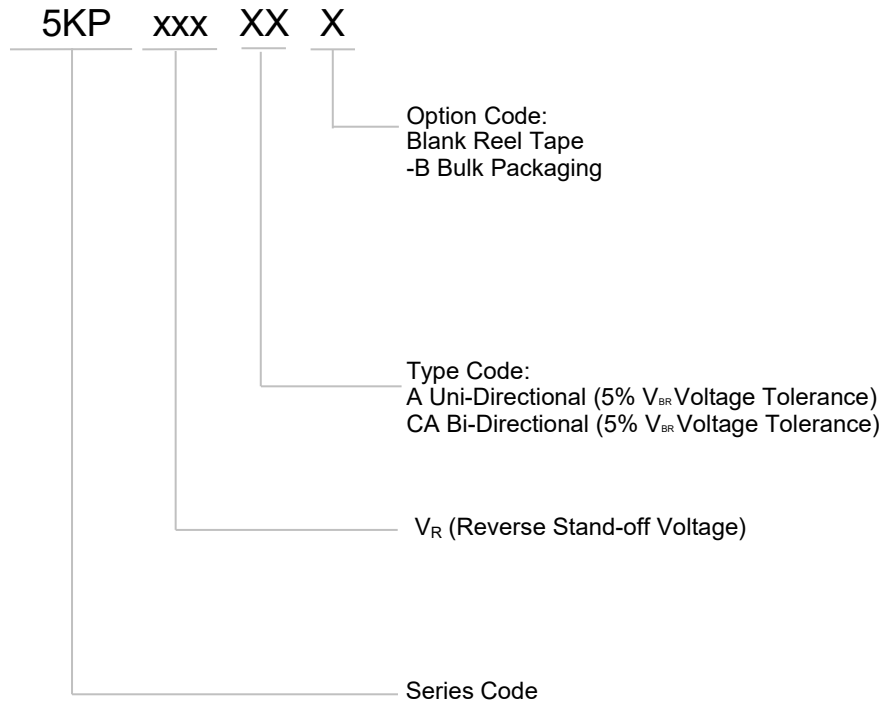

Marking

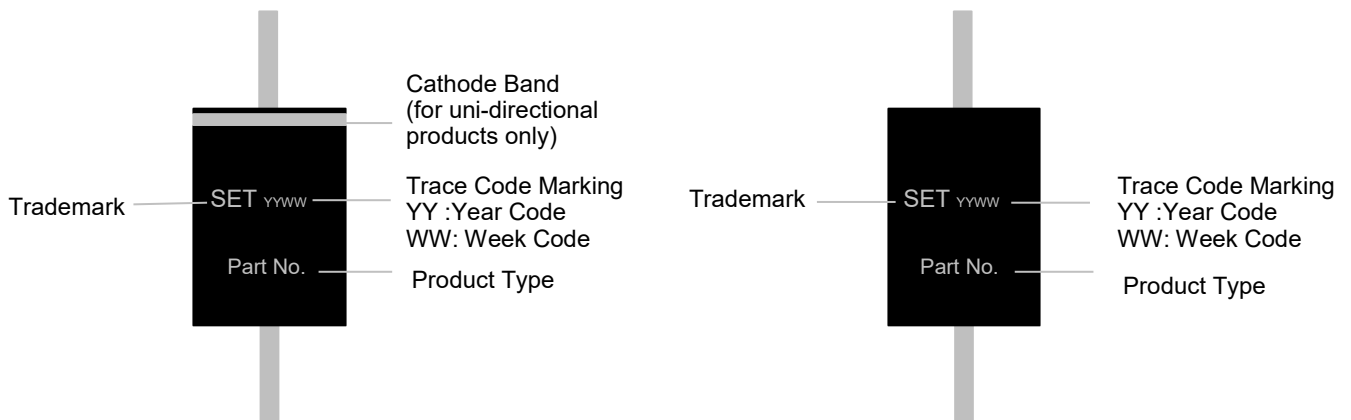

Electrical Characteristics (T_A=25 °C unless otherwise noted)

Part Number		Breakdown Voltage V _{BR@I_T}		Test Current I _T	Reverse Stand-off Voltage V _R	Max. Reverse Leakage I _{R@V_R}	Max. Peak Pulse Current I _{PPM}	Max. Clamping Voltage V _{C@I_{PPM}}
		Min	Max					
Uni	Bi	(V)		(mA)	(V)	(μA)	(A)	(V)
5KP5.0A	5KP5.0CA	6.40	7.00	50	5.00	5000.00	554.30	9.20
5KP6.0A	5KP6.0CA	6.67	7.37	50	6.00	5000.00	495.10	10.30
5KP6.5A	5KP6.5CA	7.22	7.98	50	6.50	2000.00	455.40	11.20
5KP7.0A	5KP7.0CA	7.78	8.60	50	7.00	1000.00	425.00	12.00
5KP7.5A	5KP7.5CA	8.33	9.21	5	7.50	250.00	395.30	12.90
5KP8.0A	5KP8.0CA	8.89	9.83	5	8.00	150.00	375.00	13.60
5KP8.5A	5KP8.5CA	9.44	10.40	5	8.50	50.00	354.20	14.40
5KP9.0A	5KP9.0CA	10.00	11.10	5	9.00	20.00	331.20	15.40
5KP10A	5KP10CA	11.10	12.30	5	10.00	15.00	300.00	17.00
5KP11A	5KP11CA	12.20	13.50	5	11.00	2.00	280.20	18.20
5KP12A	5KP12CA	13.30	14.70	5	12.00	2.00	256.30	19.90
5KP13A	5KP13CA	14.40	15.90	5	13.00	2.00	237.20	21.50
5KP14A	5KP14CA	15.60	17.20	5	14.00	2.00	219.80	23.20
5KP15A	5KP15CA	16.70	18.50	5	15.00	2.00	209.00	24.40
5KP16A	5KP16CA	17.80	19.70	5	16.00	2.00	196.20	26.00
5KP17A	5KP17CA	18.90	20.90	5	17.00	2.00	184.80	27.60
5KP18A	5KP18CA	20.00	22.10	5	18.00	2.00	174.70	29.20
5KP20A	5KP20CA	22.20	24.50	5	20.00	2.00	157.40	32.40
5KP22A	5KP22CA	24.00	26.90	5	22.00	2.00	143.70	35.50
5KP24A	5KP24CA	26.70	29.50	5	24.00	2.00	131.10	38.90
5KP26A	5KP26CA	28.90	31.90	5	26.00	2.00	121.10	42.10
5KP28A	5KP28CA	31.10	34.40	5	28.00	2.00	112.30	45.40
5KP30A	5KP30CA	33.30	36.80	5	30.00	2.00	105.40	48.40
5KP33A	5KP33CA	36.70	40.60	5	33.00	2.00	95.70	53.30
5KP36A	5KP36CA	40.00	44.20	5	36.00	2.00	87.80	58.10

Part Number		Breakdown Voltage $V_{BR@I_T}$		Test Current I_T	Reverse Stand-off Voltage V_R	Max. Reverse Leakage $I_R@V_R$	Max. Peak Pulse Current I_{PPM}	Max. Clamping Voltage $V_C@I_{PPM}$
		Min	Max					
Uni	Bi	(V)		(mA)	(V)	(μ A)	(A)	(V)
5KP40A	5KP40CA	44.40	49.10	5	40.00	2.00	79.10	64.50
5KP43A	5KP43CA	47.80	52.80	5	43.00	2.00	73.50	69.40
5KP45A	5KP45CA	50.00	55.30	5	45.00	2.00	70.20	72.70
5KP48A	5KP48CA	53.30	58.90	5	48.00	2.00	65.90	77.40
5KP51A	5KP51CA	56.70	62.70	5	51.00	2.00	61.90	82.40
5KP54A	5KP54CA	60.00	66.30	5	54.00	2.00	58.60	87.10
5KP58A	5KP58CA	64.40	71.20	5	58.00	2.00	54.50	93.60
5KP60A	5KP60CA	66.70	73.70	5	60.00	2.00	52.70	96.80
5KP64A	5KP64CA	71.10	78.60	5	64.00	2.00	49.50	103.00
5KP70A	5KP70CA	77.80	86.00	5	70.00	2.00	45.10	113.00
5KP75A	5KP75CA	83.30	92.10	5	75.00	2.00	42.10	121.00
5KP78A	5KP78CA	86.70	95.80	5	78.00	2.00	40.50	126.00
5KP85A	5KP85CA	94.40	104.00	5	85.00	2.00	37.20	137.00
5KP90A	5KP90CA	100.00	111.00	5	90.00	2.00	34.90	146.00
5KP100A	5KP100CA	110.00	123.00	5	100.00	2.00	31.50	162.00
5KP110A	5KP110CA	122.00	135.00	5	110.00	2.00	28.80	177.00
5KP120A	5KP120CA	133.00	147.00	5	120.00	2.00	26.40	193.00
5KP130A	5KP130CA	144.00	159.00	5	130.00	2.00	24.40	209.00
5KP150A	5KP150CA	167.00	185.00	5	150.00	2.00	21.00	243.00
5KP160A	5KP160CA	178.00	197.00	5	160.00	2.00	19.70	259.00
5KP170A	5KP170CA	189.00	209.00	5	170.00	2.00	18.50	275.00
5KP180A	5KP180CA	200.00	221.00	5	180.00	2.00	17.50	292.00
5KP190A	5KP190CA	211.00	233.00	5	190.00	2.00	16.50	310.00
5KP200A	5KP200CA	222.00	246.00	5	200.00	2.00	15.50	329.20
5KP210A	5KP210CA	233.00	258.00	5	210.00	2.00	14.60	349.50
5KP220A	5KP220CA	244.00	270.00	5	220.00	2.00	13.70	371.10
5KP250A	5KP250CA	277.00	306.00	5	250.00	2.00	12.00	425.00

Notes:

1. Measured of 8.3 ms single half sine-wave or equivalent square wave, duty cycle=4 pulses per minute maximum.
2. $V_F < 3.5$ V for single die parts and $V_F < 5.0$ V for stacked-die parts.
3. For bidirectional type having V_R of 10 volts and less, the I_R should be doubled.

I-V Curve Characteristics

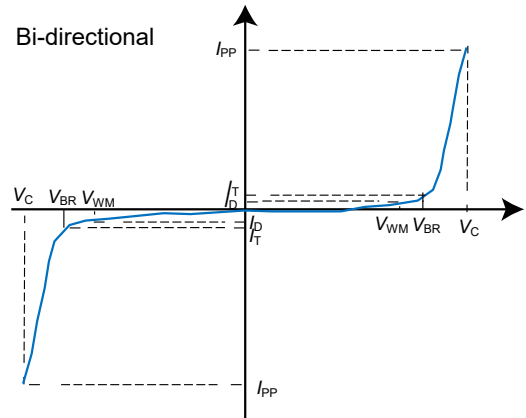
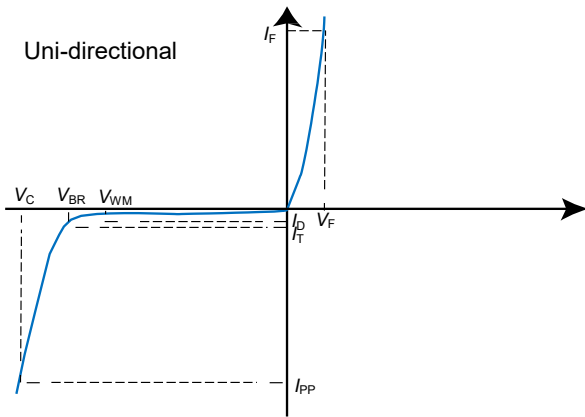

Performance Curve for Reference ($T_A=25^\circ\text{C}$ unless otherwise noted)

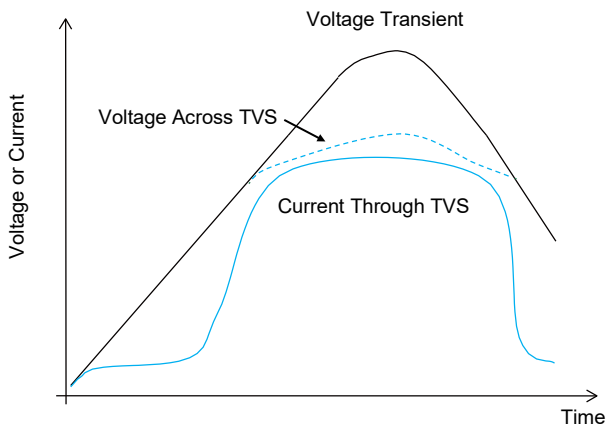

FIGURE 1 TVS Transients Clamping Waveform

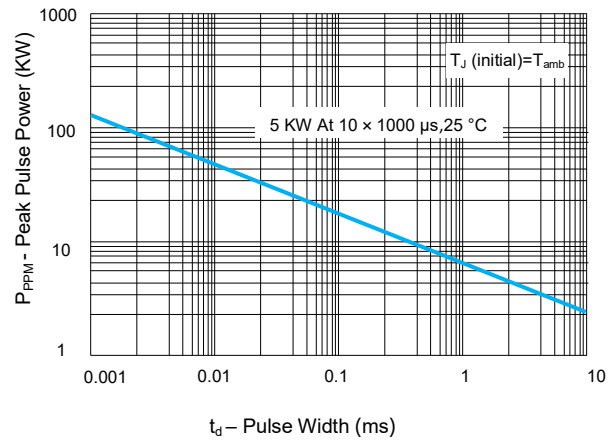

FIGURE 2 Peak Pulse Power Rating Curve

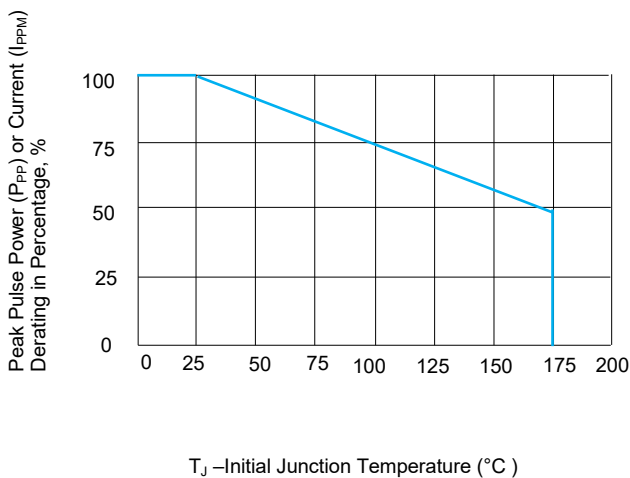

FIGURE 3 Peak Pulse Power Derating Curve

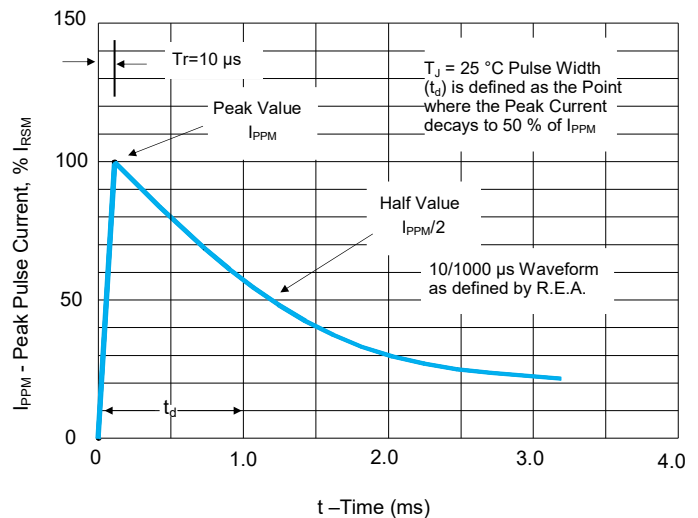

FIGURE 4 Pulse Waveform

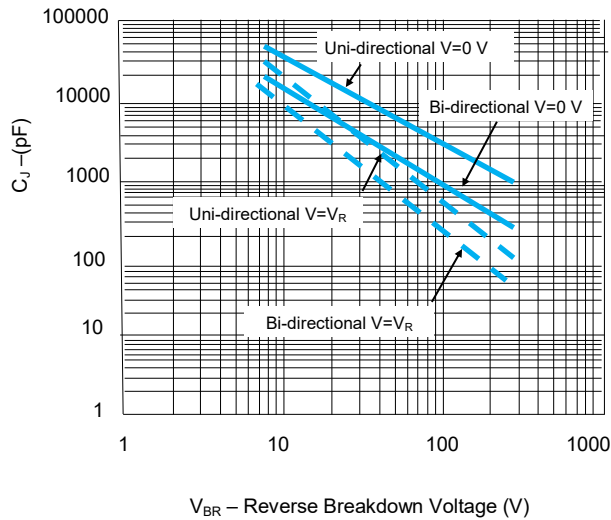

FIGURE 5 Typical Junction Capacitance

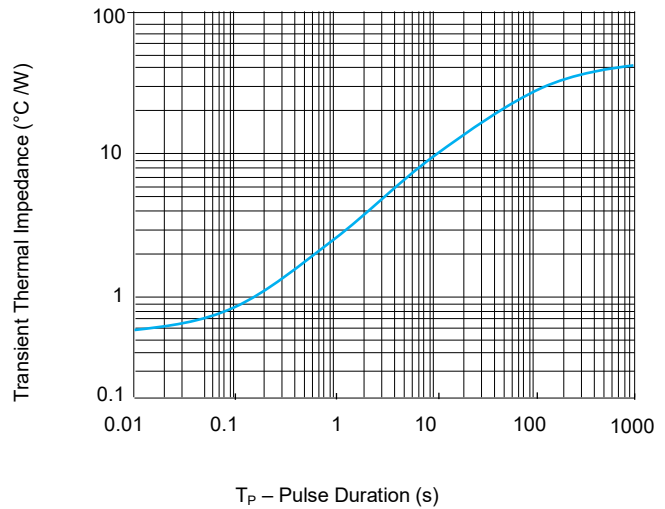

FIGURE 6 Typical Transient Thermal Impedance

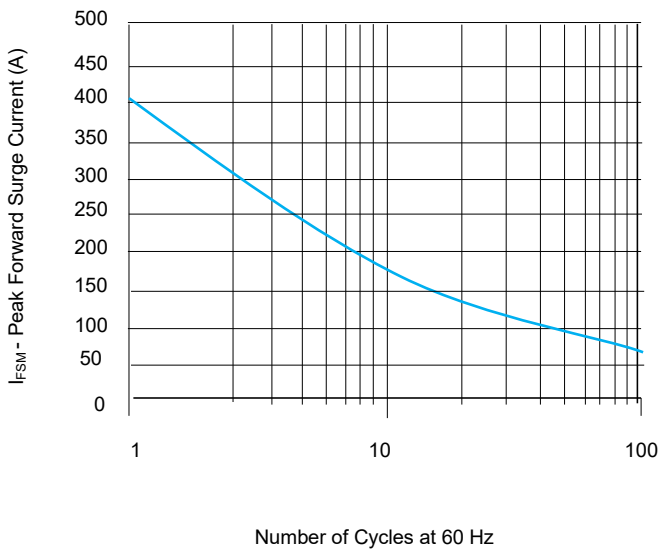

FIGURE 7 Maximum Non-Repetitive Forward Surge Current
Uni-Directional only

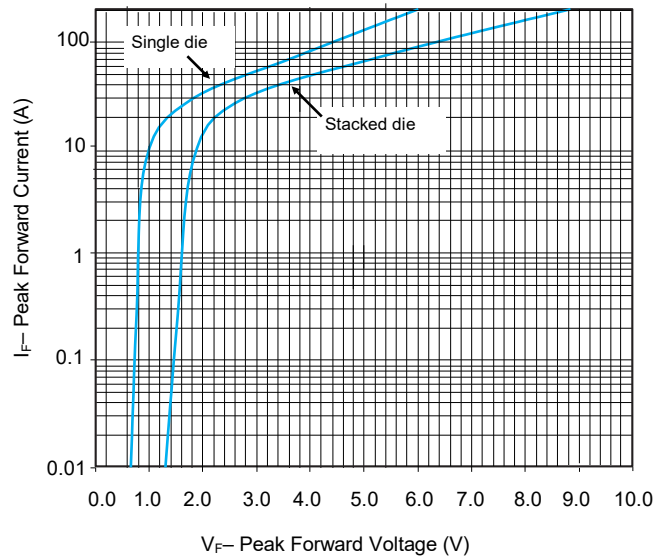

FIGURE 8 Peak Forward Drop VS Peak Forward Current
(Typical Values)

Environmental Specifications

High Temp. Storage	JESD22-A103
HTRB	JESD22-A108
Temperature Cycling	JESD22-A104
H3TRB	JESD22-A101
RSH	JESD22-B106

Physical Specifications

Weight	0.07 oz., 2.1 g
Case	P600 molded plastic body over passivated junction.
Polarity	Color band denotes the cathode except Bipolar.
Terminal	Matte Tin axial leads, solderable per JESD22-B102.

Soldering Parameters

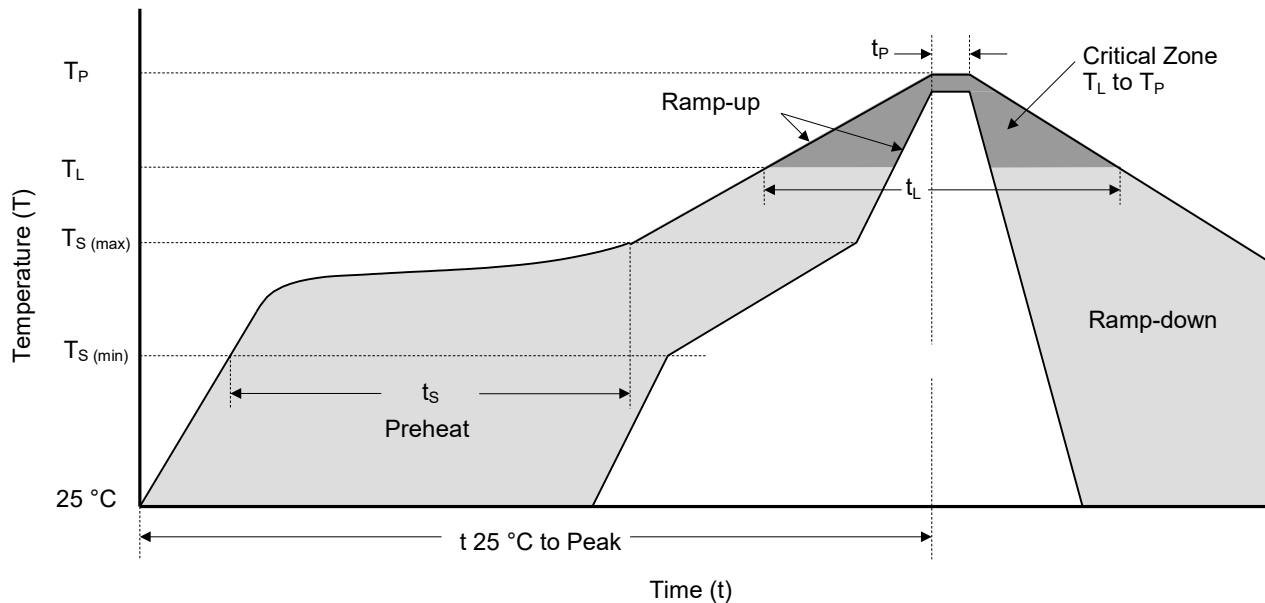

Reflowing Condition

Reflow Soldering Parameters		Lead-Free Assembly
Pre-heat	Temperature Min ($T_{S(min)}$)	150 °C
	Temperature Max ($T_{S(max)}$)	200 °C
	Time (min to max) (t_s)	60 ~ 120 seconds
Average Ramp Up Rate (Liquidus Temp (T_L) to Peak)		3 °C / second max.
$T_{S(max)}$ to T_L Ramp-up Rate		3 °C / second max.
Reflow	Temperature (T_L) (Liquidus)	217 °C
	Time (min to max) (t_L)	60 ~ 150 seconds
Peak Temperature (T_P)		260 ^{+0/-5} °C
Time of within 5 °C of Actual Peak Temperature (t_p)		20 ~ 40 seconds
Ramp-down Rate		6 °C / second max.
Time from 25 °C to Peak Temperature		8 Minutes max.
Do Not Exceed		260 °C

Flow/Wave Soldering (Solder Dipping)

Peak Temperature	260 °C+0 /- 5 °C
Dipping Time	10 seconds
Soldering Number	1 time

Packaging Information

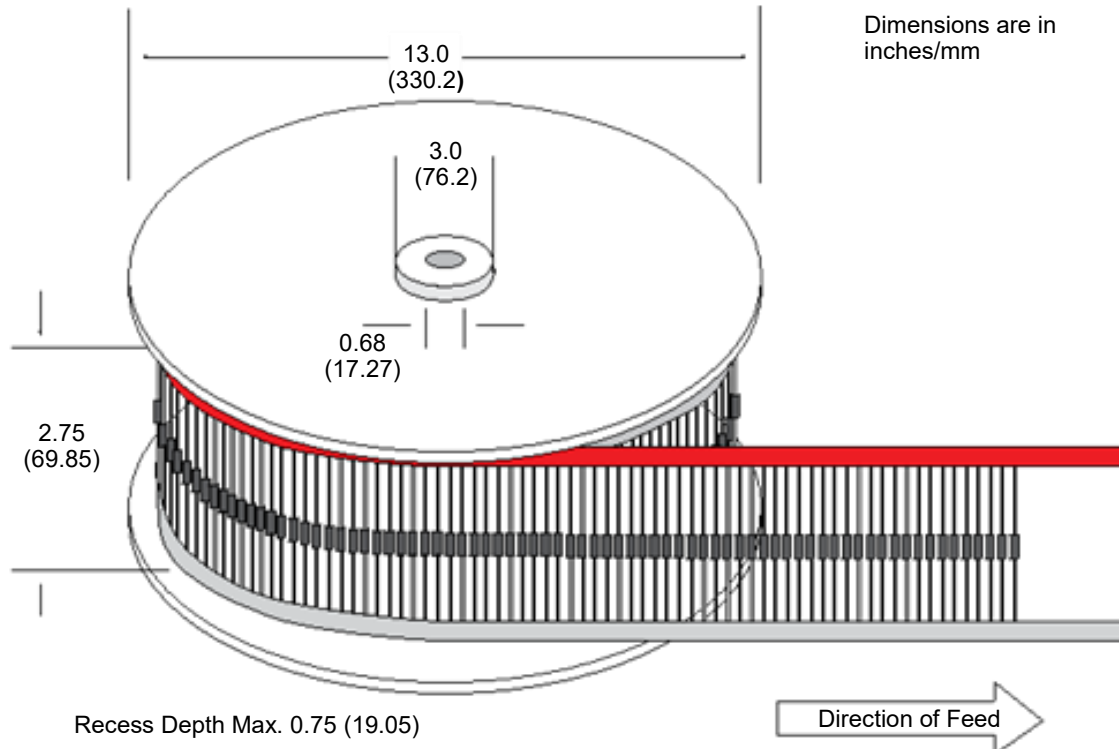
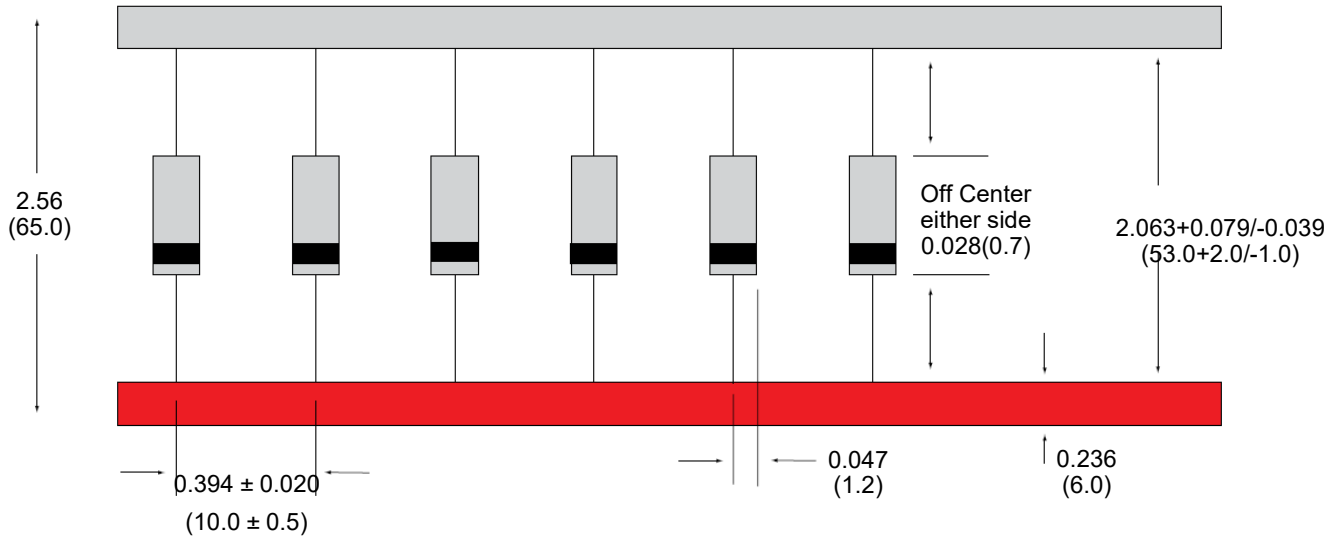

Part Number	Package	QTY's (Reel)	Packaging Option	Packaging Specification
5KPxxxXX	P600	800 PCS	Tape & Reel	EIA STD RS-296
5KPxxxXX-TB	P600	300 PCS	TB	/
5KPxxxXX-B	P600	100 PCS	BULK	SETsafe SETfuse Spec

Glossary

Item	Description
V_C	Clamping Voltage Voltage across TVS in a region of low differential resistance that serves to limit the voltage across the device terminals.
V_R	Reverse Stand-off Voltage Maximum voltage that can be applied to the TVS without operation. NOTE : It is also shown as V_{WM} (maximum working voltage (maximum d.c. voltage)) and known as rated stand-off voltage (V_{so}).
I_R	Reverse Leakage Current Current measured at V_R . NOTE : Also shown as I_D for stand-by current.
V_{BR}	Breakdown Voltage Voltage across TVS at a specified current I_T in the breakdown region.
I_{PPM}	Rated Random Recurring Peak Impulse Current Maximum-rated value of random recurring peak impulse current that may be applied to a device.
$P_{M(AV)}$	Rated Average Power Dissipation Maximum-rated value of power dissipation resulting from all sources, including transients and standby current, averaged over a short period of time.
P_{PPM}	Rated Random Recurring Peak Impulse Power Dissipation Maximum-rated value of the product of rated random recurring peak impulse current (I_{PPM}) multiplies by specified maximum clamping voltage (V_C).
C_J	Capacitance Capacitance across the TVS measured at a specified frequency and voltage.
V_{FS}	Peak Forward Surge Voltage Peak voltage across an TVS for a specified forward surge current (I_{FS}) and time duration. NOTE : Also shown as V_F .
I_{FS}	Forward Surge Current Pulsed current through TVS in the forward conducting region. NOTE : Also shown as I_F .
$\alpha_{V(BR)}$	Temperature Coefficient of Breakdown Voltage The change of breakdown voltage divided by the change of temperature.
I_{PP}	Peak pulse Current Peak pulse current value applied across the TVS to determine the clamping voltage V_C for a specified wave shape.
I_T	Pulsed D.C. Test Current Test current for measurement of the breakdown voltage V_{BR} . This is defined by the manufacturer and usually given in milliamperes with a pulse duration of less than 40 ms. NOTE : Also shown as I_{BR} .

—(GB-T 18802.321 / IEC 61643-321 / JESD210A)



ATTENTION

Usage

1. TVS must be operated in the specified ambient temp.
2. Do not clean the TVS with strong polar solvent such as ketone, esters, benzene and halogenated hydrocarbon, to avoid damaging the encapsulating layer.
3. Please do not apply severe vibration, shock or pressure to TVS, to avoid element cracking.

Replacement

1. If TVS is visually damaged, please replace it.
2. TVS is a non-repairable product. For safety sake, please use equivalent TVS for replacement.

Storage

1. Storage Temp. Range: (-55 to 150) °C.
2. Do not store the TVS at the high temp., high humidity or corrosive gas environment, to avoid influencing the solder-ability of the lead wires. The product shall be used up within 1 year after receiving the goods.

Environmental Conditions

1. TVS should not be exposed to the open air, nor direct sunshine.
2. TVS should avoid rain, water vapor or other condition of high temp. and high humidity.
3. TVS should avoid sand dust, salt mist, or other harmful gases.

Max. Typical Capacitance of TVS

The typical capacitance of TVS is listed in the specifications. Designers may refer to it when designing TVS in High frequency circuit.

Installation Mechanical Stress

1. Do not knock TVS when installing, to avoid mechanical damage.
2. Please do not apply severe vibration, shock or pressure to TVS, to avoid surface resin or element cracking.

Transient Voltage Suppressor (Surface Mount) Features Overview

Package Type	Series	Series	Series	Series	Series	Series	Series	Series	Series
DO-221AC						SMA6L			
DO-214AA							SACB	SMBJ	P6SMB
DO-214AB									
DO-214AC			SMAJ	P4SMA	SMA6J				
SOD-123FL	SMF	P4SMF							
SMT0-218									
Product Outline (mm)									
V_R / V_{WM} (V) Reverse Stand-off Voltage	5.0 ~ 250	5.0 ~ 85	5.0 ~ 440	5.8 ~ 468	5.0 ~ 250	5.0 ~ 50	5.0 ~ 440	5.8 ~ 512	
P_{PPM} (W) (10/1000 μ s) Rated Peak ImPulse Power Dissipation	200		400		600	500		600	
I_{PPM} (kA)(8/20 μ s) Rated Peak ImPulse Current									
Operating Temperature (°C)	-55 to +150								

Transient Voltage Suppressor (Surface Mount) Features Overview

Package Type	Series									
DO-221AC	○	○	○	○	○	○	○	○	○	○
DO-214AA	○	○	○	○	○	○	○	○	○	○
DO-214AB	SMCJ	1.5SMC	3.0SMCJ	SMDJ	5.0SMDJ	○	○	○	○	○
DO-214AC	○	○	○	○	○	○	○	○	○	○
SOD-123FL	○	○	○	○	○	○	○	○	○	○
SMT0-218	○	○	○	○	○	SPC1	SPC3	SPC6	SPC10	○
Product Outline (mm)										
V_R / V_{WM} (V) Reverse Stand-off Voltage	5.0 ~ 440	5.8 ~ 512	5.0 ~ 440	12 ~ 170	380 / 430	66	58 ~ 76	58 ~ 86		
P_{PPM} (W) (10/1000 μ s) Rated Peak ImPulse Power Dissipation	1500		3000	5000			○			
I_{PPM} (kA)(8/20 μ s) Rated Peak ImPulse Current			○		1	3	6	10		
Operating Temperature (°C)			-55 to +150				-55 to +125			

Transient Voltage Suppressor (Axial Lead) Features Overview

Package Type	Series																
	DO-201	DO-41	DO-15	P600	Radial lead	1.5KE	LCE										
	○	○	○	○	○	○	○	○	○	○	○	○	○	○	○	○	
	P4KE	○	○	○	○	○	○	○	○	○	○	○	○	○	○	○	
	○	SAC	P6KE	○	○	○	○	○	○	○	○	○	○	○	○	○	
	○	○	○	○	○	○	○	5KP	15KPA	20KPA	30KPA	○	○	○	○	○	
	○	○	○	○	○	○	○	○	○	○	○	SPCL1	SPCL3	SPCL6	SPCL10	SPCL15	SPCL20
Product Outline (mm)																	
V_R / V_{WM} (V) Reverse Stand-off Voltage	5.8 ~ 468	5.0 ~ 50	5.8 ~ 512	5.8 ~ 512	6.5 ~ 90	5.0 ~ 250	17 ~ 280	20 ~ 300	28 ~ 360	76	15 ~ 430	30 ~ 430	15 ~ 530	58 ~ 380	16 ~ 76		
P_{PPM} (W) (10/1000 μ s) Rated Peak Impulse Power Dissipation	400	500	600	1500	5000	15000	20000	30000					○				
I_{PPM} (kA)(8/20 μ s) Rated Peak Impulse Current					○					1	3	6	10	15	20		
Operating Temperature (°C)					-55 to +150									-55 to +125			